

Contents

Contents	2	Opacity	21
Copyright	4	Transfer Mode	22
Path Tools Introduction	5	Extras (Group)	23
Rakka	6	Motion Blur Limit	23
Controls	7	Wiggle Stroke	24
Mask Path	7	Controls	25
:Path Segment Control Group Overview:	8	Mask Path	25
Path Segment (Group)	9	:Path Segment Control Group Overview:	26
Cycle Path	9	Path Segment (Group)	27
Start % and End %	9	Start At % and End At %	27
Phase	9	Phase	27
Full Path Overlap Options (Sub-group)	9	Brush Color	27
Fixed Start Point	9	Brush Radius	27
Overlap At %	10	Brush Hardness	27
Layer	10	Brush Opacity	27
Repetitions	10	:Wiggle Control Groups Overview:	28
Auto-Orient	10	Wiggle Position (Group)	33
:Transform Control Groups Overview:	11	Wiggle Type (P)	33
Scale Controls (Group)	14	Amount (P)	33
Scale	14	Periods (P)	33
Oppose Alternate	14	Offset % (P)	33
Random Instance Scale (Sub-group)	14	Evolve (P)	33
X & Y Separate	14	Evolve Loop Period (P)	33
X and Y Scale Random, Scale Random	14	Noise Wave Loops (P)	33
Random Seed (S)	14	Wotate	34
Position Controls (Group)	15	Twists	34
Offset	15	Twist Can Offset	34
X and Y Offset	15	Wiggle Radius (Group)	35
Random Instance Offset (Sub-group)	15	Wiggle Type (R)	35
X and Y Offset Random	15	Amount (R)	35
Random Seed (P)	15	Periods (R)	35
Rotation Controls (Group)	16	Offset % (R)	35
Rotation	16	Evolve (R)	35
Twist Path (Sub-group)	16	Evolve Loop Period (R)	35
Start Rotation	16	Noise Wave Loops (R)	35
End Rotation	16	Wiggle Opacity (Group)	36
Flip Y On Rotation	16	Wiggle Type (O)	36
Random Instance Rotation (Sub-group)	16	Amount (O)	36
Rotation Random	16	Periods (O)	36
Random Seed (R)	16	Offset % (O)	36
:Taper Control Groups Overview:	17	Evolve (O)	36
Taper Path (Group)	21	Evolve Loop Period (O)	36
Editor (TP)	21	Noise Wave Loops (O)	36
Opacity (TP)	21	:Taper Control Groups Overview:	37
Size (TP)	21	Taper Segment (Group)	41
Taper Segment (Group)	21	Editor (TS)	41
Editor (TS)	21	Position (TS)	41
Opacity (TS)	21	Radius (TS)	41
Size (TS)	21	Opacity (TS)	41

CFX Path Tools - Cycore Systems FX menu

Taper Path (Group)	41
Editor (TP)	41
Position (TP)	41
Radius (TP)	41
Opacity (TP)	41
:Repeat Control Group Overview:	42
Repeat (Group)	43
Repetitions	43
Randomize Position Wiggle	43
Position Offset Delta	43
Position Evolve Delta	43
Randomize Radius Wiggle	43
Radius Offset Delta	43
Radius Evolve Delta	43
Randomize Opacity Wiggle	43
Opacity Offset Delta	44
Opacity Evolve Delta	44
:Extras Control Group Overview:	45
Extras (Group)	47
Brush Transfer Mode	47
Color Gradient (Sub-group)	47
Segment Gradient	47
Repetition Gradient	47
First In Color	47
First Out Color	47
Last In Color	47
Last Out Color	47
Random Seed	47
Synchronize Noise Seeds	48
Thanks To	49

Copyright

© 2008 Cycore Systems AB. All rights reserved. All rights to the trademarks/trade-names Cycore Effects, Cycore FX, CycoreFX, CFX and CFX Path Tools shall remain at all times the sole property of Cycore Systems AB. All other trademarks are the property of their respective companies. The Cycore Effects software described in this document is furnished under a license agreement. The software may be used or backed up only in accordance with the terms of the agreement. Information in this document is subject to change without notice and does not represent product specification or commitment on the part of Cycore Systems AB. No part of this document may be reproduced, transmitted, transcribed, stored in a retrieval system, or translated into any language in any form without written permission from Cycore Systems AB. Adobe and After Effects are registered trademarks of Adobe, Inc. All other product names mentioned in this document are used for identification purposes only and may be trademarks or registered trademarks of their respective companies. Registered and unregistered trademarks used herein are the exclusive property of their respective owners. Cycore Systems AB makes no claim to any such marks, nor willingly or knowingly misused or misapplied such marks.

Path Tools Introduction

Path Tools is a package containing two powerful plug-ins, Rakka and Wiggle Stroke. The basic requirement for both plug-ins is a mask path. Rakka also needs a layer to “rack-up”, or repeat, along the selected mask path. From there, the combinations are almost endless to create original looking animations, backgrounds or effects. You can create stunning animations with minimal effort — animations that were once only possible with particle generators. Using Wiggle Stroke you can do anything from “wiggling” frames to complete crazy looking thread/wire animations, all based on a single mask path. Path Tools will become an indispensable addition to your toolbox.

We have chosen to use “overview” sections in this manual to describe several controls in more detail and include graphics to further support written text where we thought it helpful. The reason behind this is that some of these controls are common for many of the control groups and we didn’t want to repeat text/graphics throughout the manual which instead would cause clutter, making it more difficult to get to control groups and individual controls, especially when you have learned how the plug-ins work and just need a quick “refresh” of which controls did what in a control group. There are also cases where we moved controls to an overview section because sometimes “a picture says more than a thousand words”.

We strongly recommend that you download the available sample projects from our website and use as a companion to this manual.

If you feel that some part of this manual is incorrect or fails to explain a function or control properly, please send your feedback or ideas to us at: feedback@cycorefx.com.

We appreciate your opinions! (As long as they fall in line with ours)

CPT Rakka

This plug-in offers a broad range of uses. In its most basic form, Rakka functions as a timesaver for creating repeated path animations with an offset for each instance. This task otherwise involves writing complex expressions or a lot of manual work, duplicating the layer several times and doing the offset by hand. For example, if you need five instances of a layer, e.g., a logo or corn flakes package, flowing along a path, Rakka makes that a no-brainer and you have full control over scale, rotation, twist etc.

The above only scratches the surface of Rakka's potential. Rakka can be used to create anything from swirling lines to bands of pearls, from a caterpillar moving across the screen to highly organic "HR Giger like" animations. Thanks to controls for random scale, offset and rotation, transfer modes, taper controls for controlling position, scale, opacity for both paths and instances separately, to mention a few, you can create stunning animations with minimal effort — animations that were only possible with particle generators that tends to be more complicated to use.

To be able to work in a compact UI, controls have been organized in logical groups to minimize clutter. We recommend that you check out the included "Introduction" projects that spans from basic usage across to what can be created using more advanced values and settings, even taking it to the extreme.

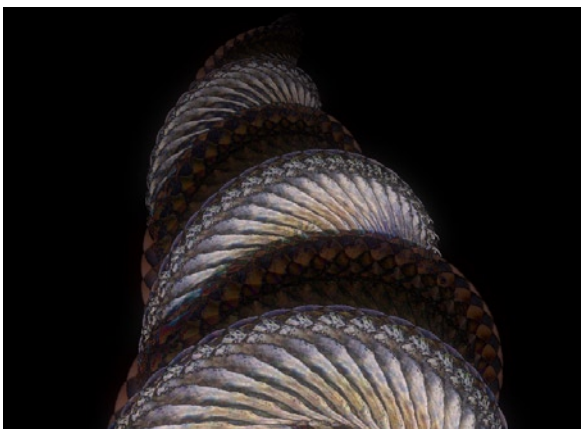

Controls

Mask Path

Use this pop-up menu to select the mask path to be used for the animation. The mask path has to reside, or be created, on the same layer as Rakka is applied to. The layer can contain several mask paths that can be selected to change the appearance of an animation. This makes it very easy to try out several options as all other settings will stay the same. If a mask path exists on the layer when Rakka is applied, the first mask path is automatically selected by default. Recommended is to use a Solid where mask paths are created and Rakka is applied.

:Path Segment Control Group Overview:

This control group contains several controls that allow to modify the mask path and control motion of instances, as well as how instances appear along the mask path when animated. In this overview individual controls are not explained in detail, instead focus is pointed at how these controls interact when combined. The first picture below shows the original mask path and a path segment defined by setting Start to 20 and End to 80. Using the original mask path, instances appear along the full length of the path. Using the path segment, instances appear in the defined segment only.

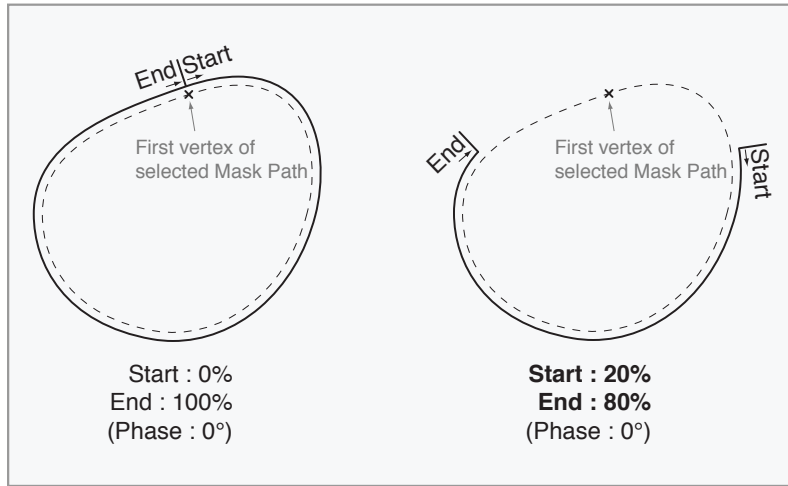

Example using Start % and End% to define a segment.

The Phase control offsets the segment defined by Start and End along the path. Cycle Path controls what happens if the segment is offset beyond either end of the path. With Cycle Path off, any instances passing beyond the path ends will be excluded. Turning on Cycle Path will cause the extending instances to wrap around to the opposite end of the path. The image below shows an example of a closed path with Cycle Path on and off.

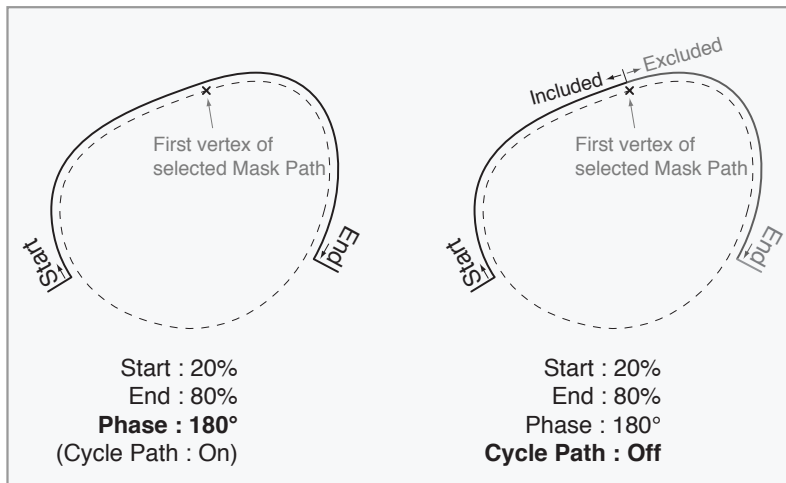

Example using Phase and Cycle Path on a segment.

Path Segment (Group)

Cycle Path

Check this option to allow instances to cycle, or loop, along the path. Speed of loops and amount are controlled by the values set in the Phase control. When this option is unchecked, using the Phase control, instances will perform one cycle along the full length of the path and then disappear.

Start % and End %

Use these controls to define a segment of the path where instances will appear. The values are in percentage and are relative to the length of the path and the number of instances set in the Repetitions control. When animating, these controls are great to combine with the Phase control but they can also be used “stand alone” to animate instances along a path as the segment of the full path is altered when changing their values. Start % and End % values can be “overlapped”, i.e., end can be set before start and vice versa.

Supervised: These controls are disabled if Fixed Startpoint is checked.

Phase

Use this control to animate and determine the speed at which instances move along the selected path. At one revolution instances move the full length of the path and are back to their original position.

Note. If Cycle Path is unchecked, turning the phase wheel over one revolution will not cycle, or loop instances, instead they will disappear after performing one full cycle.

Full Path Overlap Options (Sub-group)

These controls do not affect the position or characteristics of instances, instead their purpose is to control which instance gets drawn first.

Note. The controls in this group are used to position the overlap point (or seam) which can be visible when using certain Transfer Modes. Some Transfer Modes do not produce an overlap in which case the following controls have no effect (See Transfer Modes page 22).

Fixed Start Point

With this option checked, instances will overlap at a specific point on the path instead of at the Phase offset start point. With a static overlap point it is possible to choose where the overlap will occur which can be desired in certain cases. It also enables the Overlap At % control where the start point can be offset.

Note: This control is only used if the selected path is closed and has no effect unless instances visually overlap at some point.

Overlap At %

If Fixed Startpoint is checked, use this control to offset the starting point for instances where they overlap. The starting point where instances overlap will not be visible when Repetitions values are set low relative to the mask path length.

Supervised: This control is enabled if Fixed Startpoint is checked.

Layer

Use this pop-up menu to select the layer you want to generate instances of. Normally, the selected layer should be turned off in the Timeline to not be visible in the composition.

Note. Using very large layers can increase rendering times.

Repetitions

Use this control to set the number of instances.

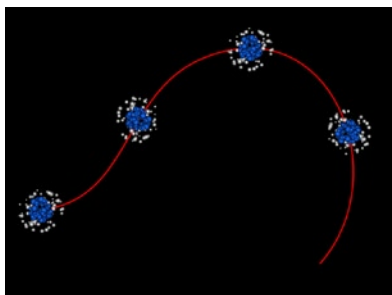

Repetitions set to 4.

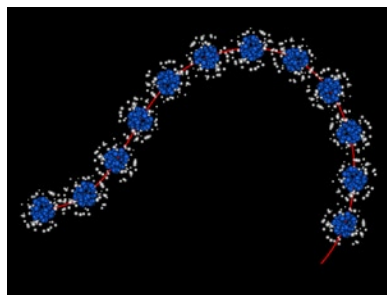

Repetitions set to 12.

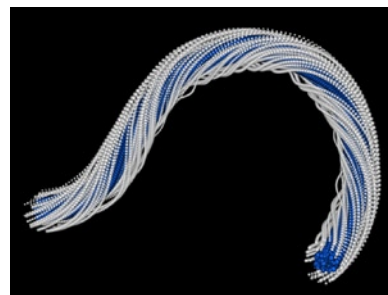

Repetitions set to 200.

Note. Using very high values can increase rendering times, especially if the selected layer is large.

Auto-Orient

With this option checked, instances faces the direction of the mask path. When unchecked, instances will use the orientation of the layer selected in the Layer control.

:Transform Control Groups Overview:

The transform control groups are Position, Scale and Rotation. The picture below show the order in which transformations are taking place as a tree, where the Off-set control in the Position group branches out the differences between setting it to Anchor point or Position when using any of the available Rotation controls.

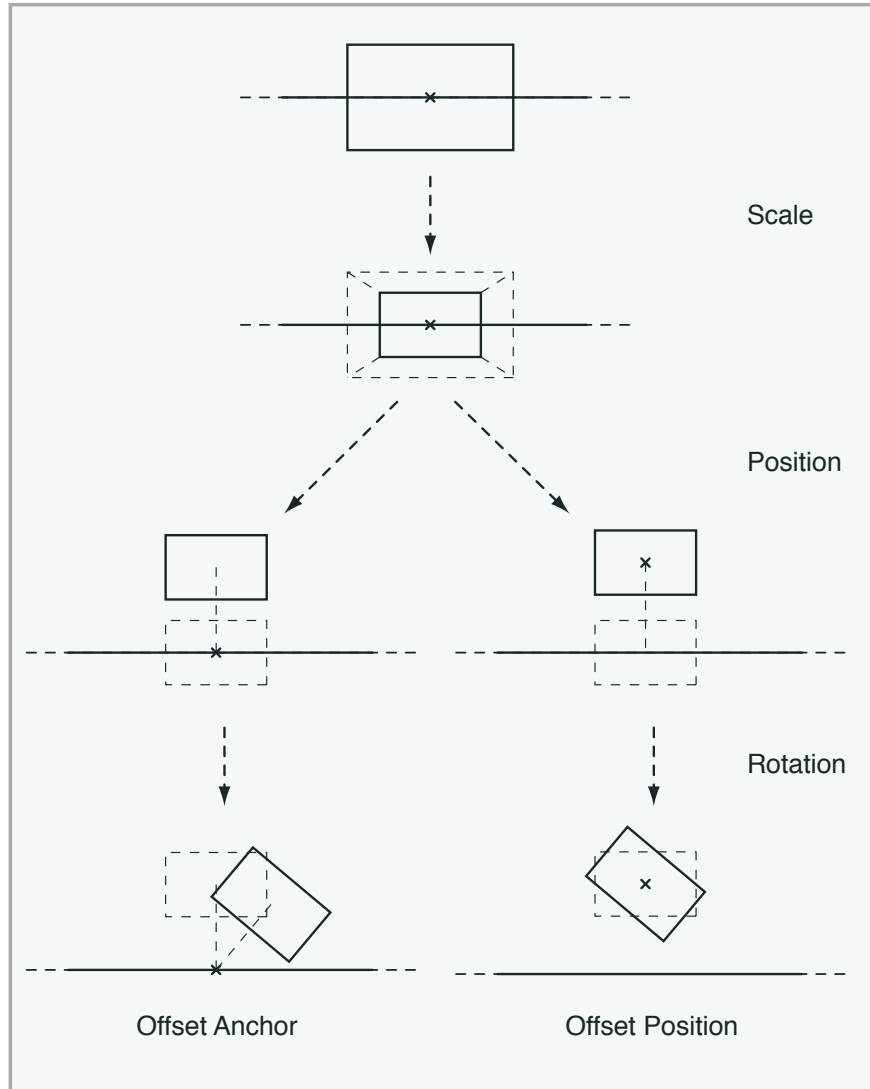

Transformation order and how offset setting affects rotation.

CPT Rakka - Cycore Systems FX menu

In the Rotation control group there is a Twist Path sub-group where start and end rotation can be set for instances. Combining these with others controls, instances are “twisted” around the mask path to give an increased sense of 3D. In the following examples there is no offset set in the Position control group. To see how rotation is affected by the selection in the Offset control please see previous page (page 11).

Ex.1: Setting Start Rotation to -90 degrees, instances will have an initial -90 degree rotation at the starting point (first vertex of mask path or position set using the Overlap control) and are rotated to the value set in End Rotation at the end point, in this example it is set to 0 degrees. See the picture below:

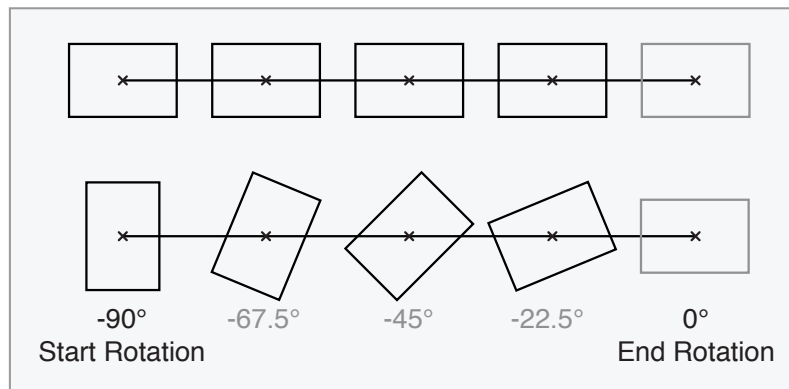

Start Rotation -90° and End rotation 0°.

Ex 2: Setting End Rotation to 90 degrees, instances will have the value set in the Start Rotation at the starting point (first vertex of mask path or position set using the Overlap control), in this example it is set to 0 degrees, and are rotated to 90 degrees at the end point. See picture below:

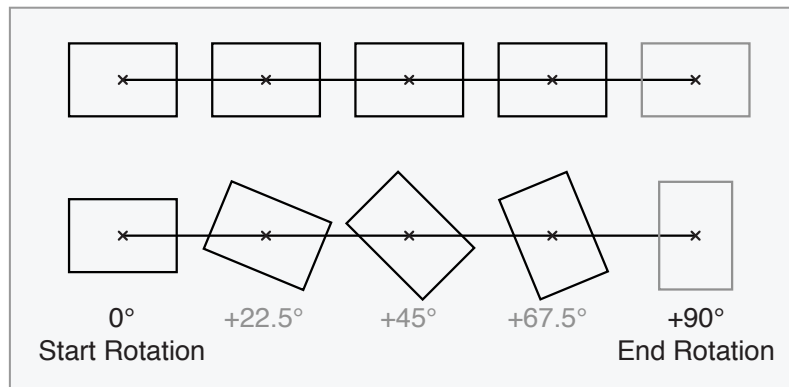

Start Rotation 0° and End rotation 90°.

To see this, use one of the above examples and check the Cycle Path check box then turn the Phase wheel 3-4 revolutions, instances will turn 90 degrees when crossing the start/end point.

CPT Rakka - Cycore Systems FX menu

Ex 3: Setting Start Rotation to -90 degrees and End Rotation to 90 degrees. Instances will have an initial -90 degree rotation at the starting point (first vertex of mask path or position set using the Overlap control) and are rotated to 90 degrees at the end point. See picture below:

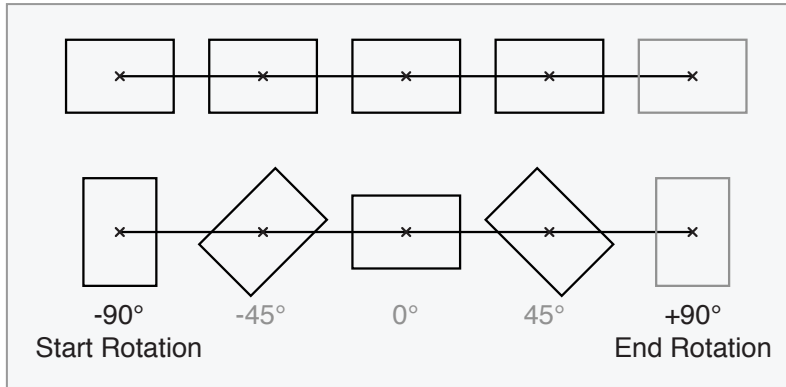

Start Rotation -90° and End rotation 90°.

Scale Controls (Group)

Scale

Use this control to scale instances proportionally. The Scale property can be combined with the X and Y Scale Random, Scale Random controls, set to fixed value(s) or animated.

Note. Scaling can increase render times.

Oppose Alternate

With this option checked, every second instance will be flipped and face in the opposing direction from its closest neighbor.

Random Instance Scale (Sub-group)

X & Y Separate

When this option is checked, the X and Y Scale Random controls are enabled to allow random scaling of instances in X and Y separately.

X and Y Scale Random, Scale Random

Use these controls to randomly scale instances. Depending on how the X & Y Separate checkbox is set, instances will be randomly scaled proportionally or in X & Y separately.

Supervised: Scale Random is enabled when X & Y Separate is unchecked.

Random Seed (S)

Use this control to set a unique random seed value for random scaling. This makes it easy to use multiple layers, using the same Rakka animation, and only changing the Random Seed value to make them look different.

Position Controls (Group)

Offset

Use this pop-up menu to determine if Anchor Point or Position should be offset.

Note. The selection in this control will be most notably different when Rotation and/or Twist values have been changed or animated. The Offset property can be combined with the X and Y Offset Random controls, set to a fixed value(s) or animated. This control does not affect scaling.

X and Y Offset

Use these controls to shift the position or anchor point of instances (If Position or Anchor points are shifted depends on the selection in the Offset pop-up menu). The shifting is relative to the mask path. Higher values will produce greater shifting of instances from the original mask path.

Random Instance Offset (Sub-group)

X and Y Offset Random

Use these controls to randomly shift the position or anchor point of instances in X & Y separately (If Position or Anchor points are shifted depends on the selection in the Offset pop-up menu). These controls can be combined with the Offset control. Higher values will produce greater shifting of instances from the original mask path.

Random Seed (P)

Use this control to set a unique random seed value for random scaling. This makes it easy to use multiple layers, using the same Rakka animation, and only changing the Random Seed value to give each layer a unique look.

Rotation Controls (Group)

Rotation

Use this control to rotate instances. The Rotation property can be combined with the Random Rotation control, set to a fixed value or animated. Use this control to determine the rotation

Twist Path (Sub-group)

Start Rotation

Use this control to set the start rotation value for instances. Combined with other rotation controls, instances are “twisted” around the mask path which results in an increased sense of 3D.

End Rotation

Use this control to set the end rotation value for instances. Combined with other rotation controls, instances are “twisted” around the mask path which results in an increased sense of 3D.

Flip Y On Rotation

When this control is checked, instances will be flipped around their X axis while rotating. Instances will be flipped using any Rotation control.

Random Instance Rotation (Sub-group)

Rotation Random

Use this control to randomly rotate instances.

Random Seed (R)

Use this control to set a unique random seed value for random scaling. This makes it easy to use multiple layers, using the same Rakka animation, and only change the Random Seed value to give each layer a unique look.

:Taper Control Groups Overview:

Tapering is often used to allow a property to become gradually smaller, less opaque etc, toward one or both ends. As Rakka use a curve editor, these controls allows for gradually decreasing/increasing properties along the full length of the mask path. As the group names imply there are two options, taper the full mask path or taper a defined segment of the mask path. Both taper options can be combined to get the desired result.

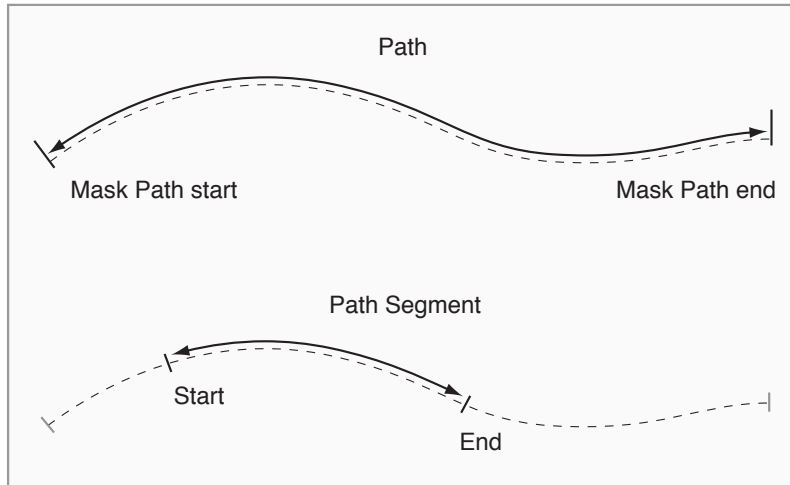

Example showing a full path and a path segment.

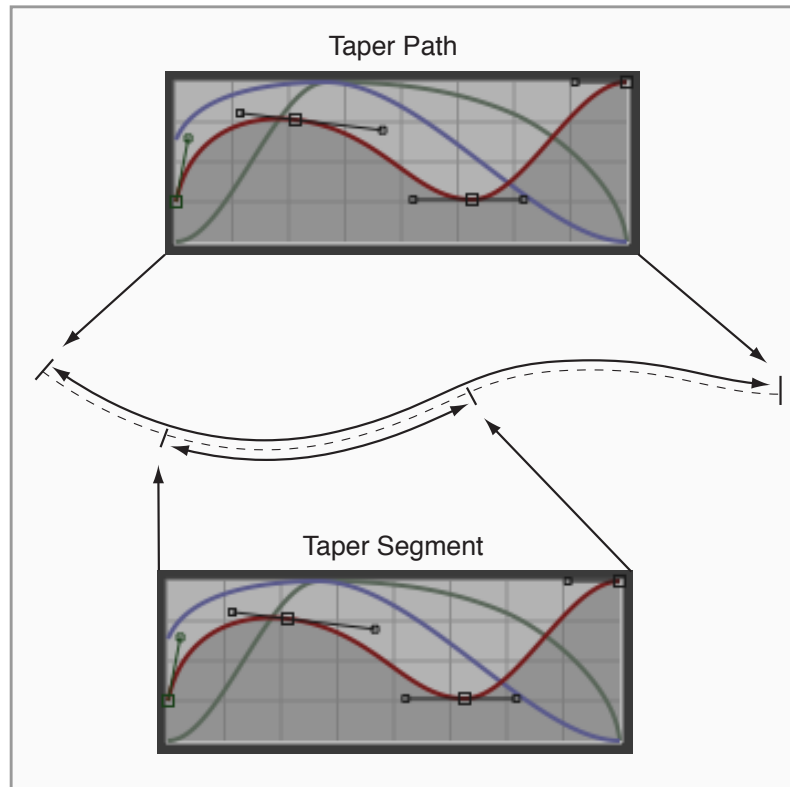

Example showing tapering a full path and/or a path segment.

CPT Rakka - Cycore Systems FX menu

Curve editors have one main editor where all available taper properties can be accessed and edited, simply press the button for the desired property to activate for editing, while still being able to view curves for other properties as they are overlaid in the UI.

If higher precision is needed for fine tuning, each property has its own curve editor representing the actual property in the main editor. These all have a larger curve editor UI and other inactive curves are not overlaid for a cleaner view. All changes done in the individual curve editors are reflected in the main editor UI. Individual taper controls can be animated.

Values are displayed in the editors interactively as you move a point. To check current values for any point, hover the mouse over the point and the current value is displayed in the After Effects Info window/panel.

Taper editors have an identifier (e.g., TS) to make it easy to quickly identify which taper property is which when working in the Timeline window/panel.

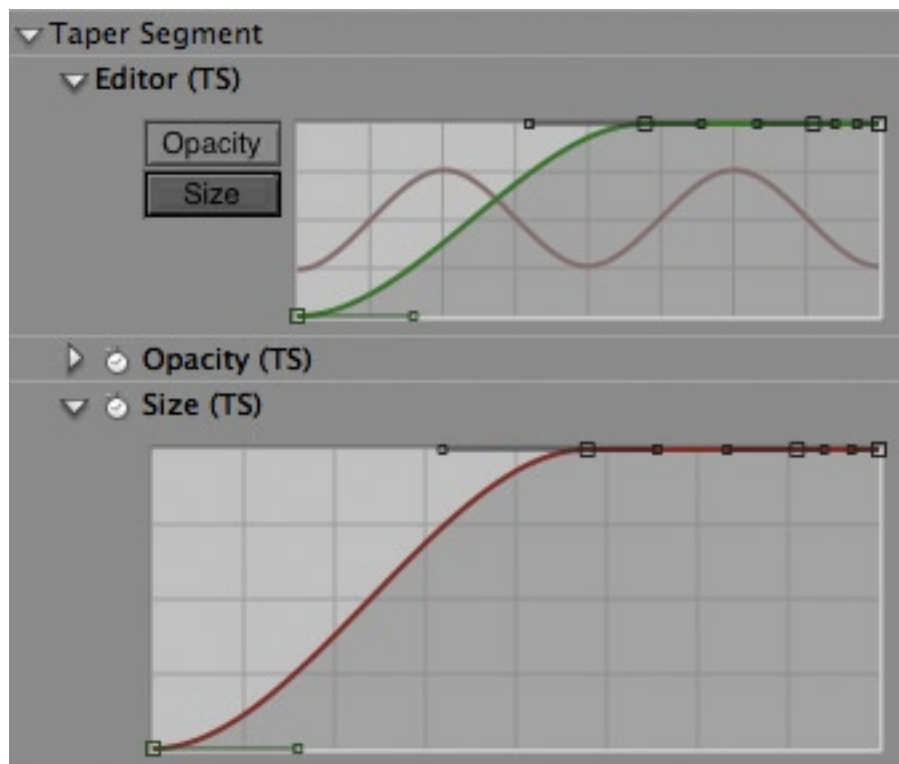

Main Editor and Solo Editor with inactive curve overlaid.

CPT Rakka - Cyccore Systems FX menu

Taper Path is applied over the whole path length. Taper Segment only affects the segment defined in Path Segment. Combining the two may occasionally cause one to cancel out the other. However, this interaction also provides great control over the applied tapering. The pictures show examples of taperings and how they interact.

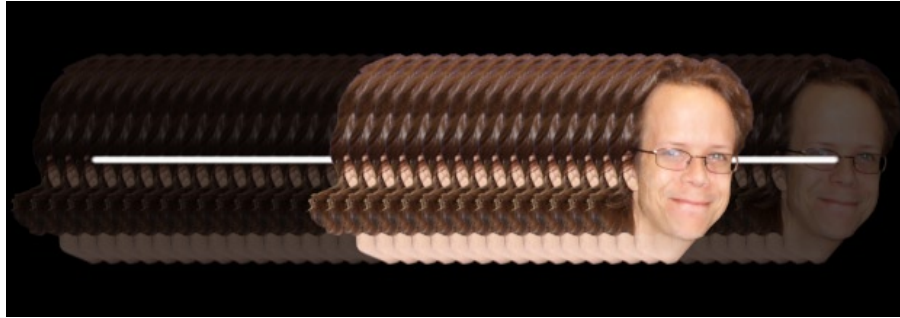

Segment defined. Start: 40 and End: 80

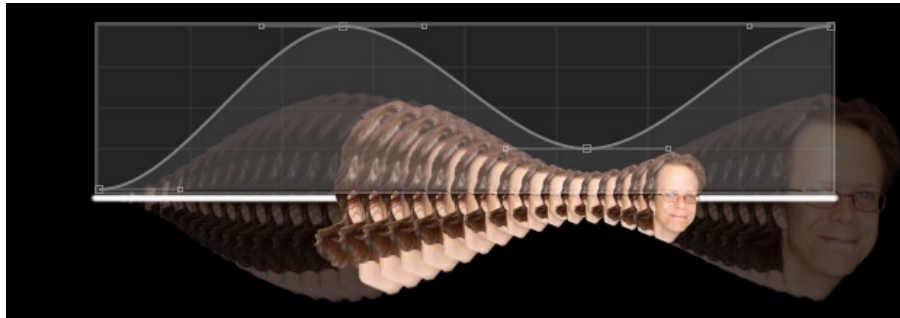

Taper Path applied.

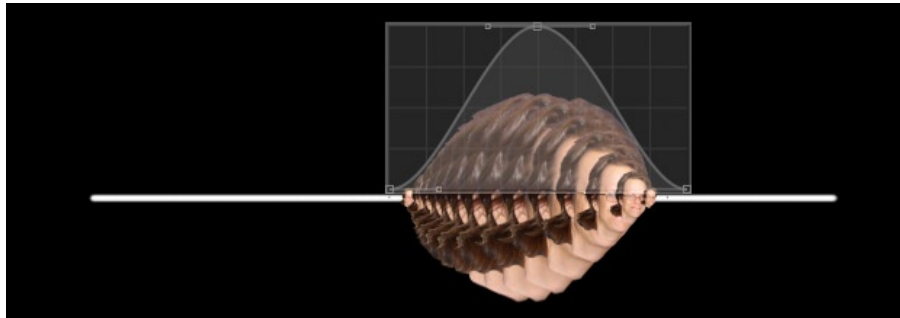

Taper Segment applied.

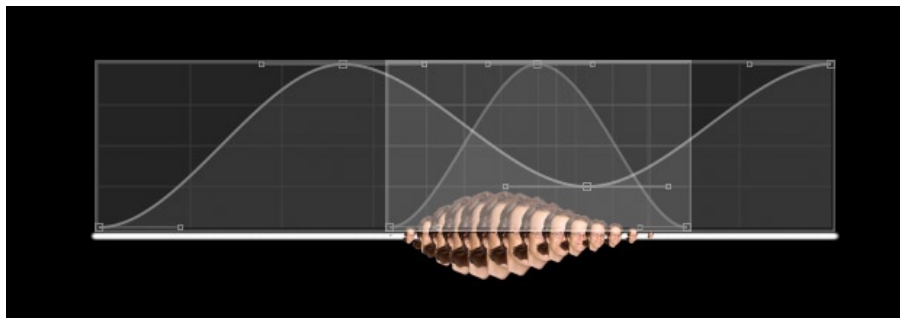

Taper Path and Taper Segment applied.

CPT Rakka - Cycore Systems FX menu

At default settings all curve editors have four vertex points, but points can also be added or removed. To add/remove points use the following modifiers:

- Add a point: Option (Alt)-click on a curve adds a point at that position.
- Remove a point: Option (Alt)-click on the point.

Note. Option-click near a handle has no effect.

Additional editing options:

- Split direction handles: Cmd (Ctrl)-click and drag a direction handle.
- Vertically move the first and last points in a curve with constraint: Shift-drag either first or last point.

Taper Path (Group)

Tapers the full mask path.

Editor (TP)

Main editor for all taper path properties. Click desired property to activate for editing. Curves for inactive properties are overlaid.

Opacity (TP)

Solo editor for opacity, providing a larger curve editor UI. Changes are reflected in Main Editor.

Size (TP)

Solo editor for size, providing a larger curve editor UI. Changes are reflected in Main Editor.

Taper Segment (Group)

Tapers the segment defined in the Path Segment control.

Editor (TS)

Main editor for all taper path properties. Click desired property to activate for editing. Curves for inactive properties are overlaid.

Opacity (TS)

Solo editor for opacity, providing a larger curve editor UI. Changes are reflected in Main Editor

Size (TS)

Solo editor for size, providing a larger curve editor UI. Changes are reflected in Main Editor.

Opacity

Use this control to determine the transparency level of instances. At 100%, instances are completely opaque. At 0%, instances are completely transparent.

Transfer Mode

Use this pop-up menu to select which composite method to use between the effect and the source layer. Each offers a different result. Choose one of the following options: Over, Under, Lighten, Screen, Add, Darken, Multiply, Overlay, Soft Light, Hard Light, Difference, Alpha Add.

Note. Some transfer modes can be used to hide start/end instance overlap when creating seamless loops.



Sharp overlap: Over, Under, Alpha Add.

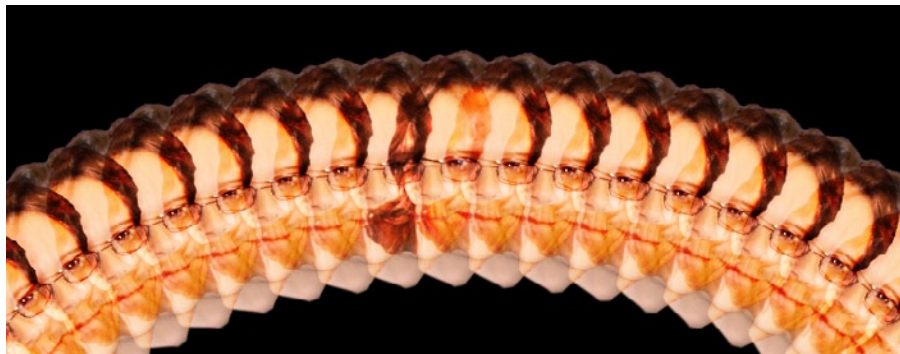

Slight overlap: Overlay, Soft Light, Hard Light, Difference.



No overlap: Lighten, Screen, Add, Darken, Multiply.

Extras (Group)

Motion Blur Limit (Only available in AE CS3 or later)

Rakka applies advanced adaptive motion blur, when enabled for the layer, to provide high quality motion blur without performing unnecessary sampling when objects are moving slow. This control allows for defining the maximum sampling quality to use for high motion objects for better control of the quality/render time ratio. The following options are available: Low, Medium, High, Extreme, Ridiculous. At default this control is set to Medium which most often is sufficient for normal usage.

Note: If motion blur is not enabled, this control will have no effect. If objects are animated with only slight motion, this control is unlikely to have any effect. With a high degree of motion involved, setting this control to Ridiculous may take up to 16 times longer to render than setting it to Low. Try out the options to find the desired quality.

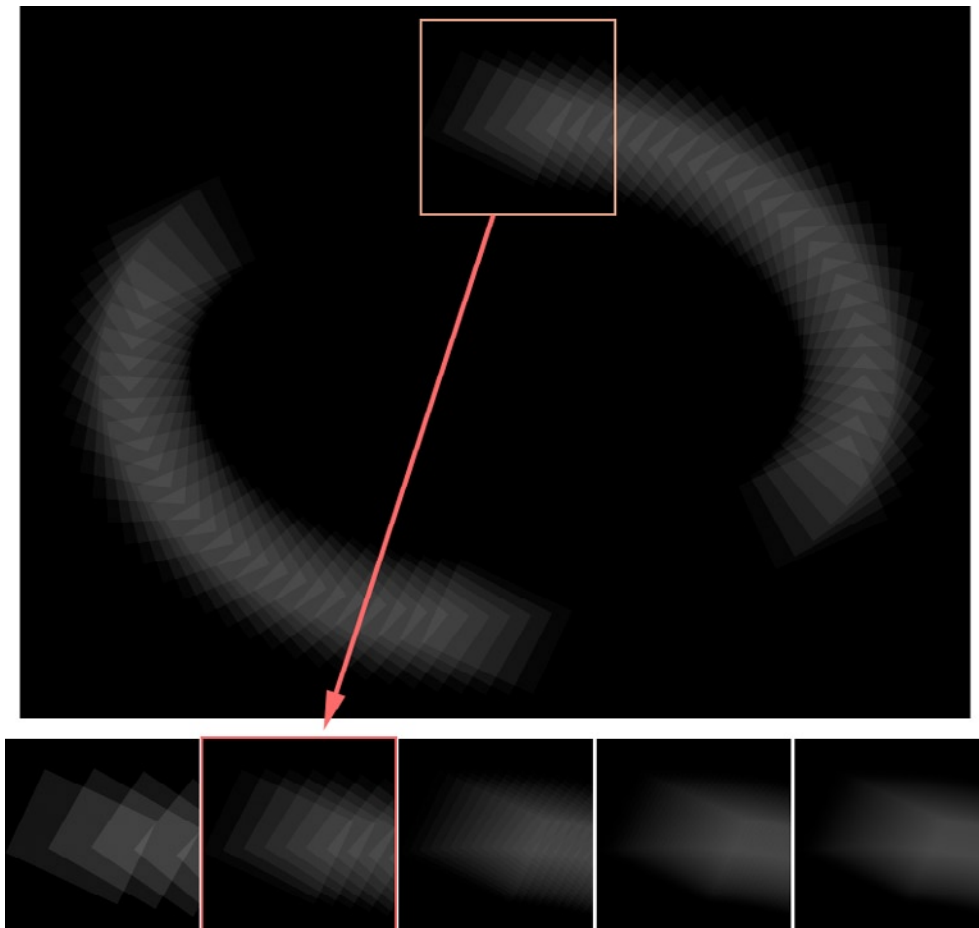

The same Rakka animation compared using the available Motion Blur Limit options.

CPT Wiggle Stroke

This plug-in offers numerous possibilities. You can do anything from the basic “wiggling” of strokes to complete crazy looking thread or geometric wire animations. Wiggle Stroke generates a stroke from a mask path. To create the wiggling effect, Wiggle Stroke use three types of modifiers to displace the stroke from the original mask path, basic noise, wave noise and wave functions. Each type has a variety of options to vary the appearance. Wiggling can be applied to position, radius and opacity individually. You will be truly amazed with what can be created from just an ellipse or straight line mask path.

To be able to work in a compact UI, controls have been organized in logical groups to minimize clutter. We recommend that you check out the included “Introduction” projects that span from basic usage across to what can be created using more advanced values and settings, even taking it to the extreme.

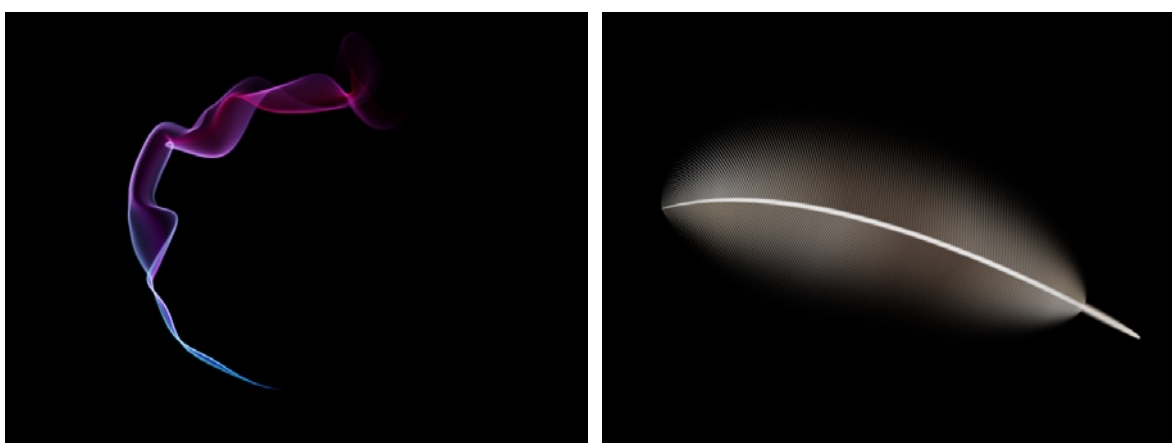
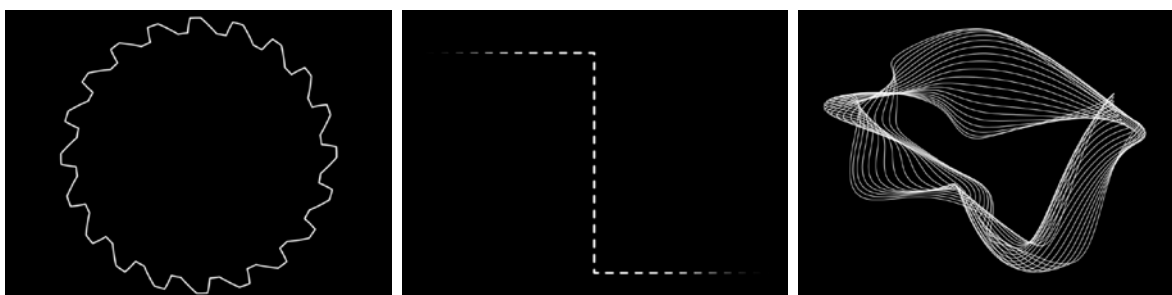

Controls

Mask Path

Use this pop-up menu to select the mask path to be used to stroke and wiggle. The mask path has to reside, or be created, on the same layer as Wiggle Stroke is applied to. The layer can contain several mask paths that can be selected to change the appearance of an animation. This makes it easy to try out several options as all other settings will remain the same. If a mask path(s) exists on the layer when Wiggle Stroke is applied, the first mask path is automatically selected by default. Recommended is to use a Solid where mask paths are created and Wiggle Stroke is applied.

:Path Segment Control Group Overview:

This control group contains several controls that allow to modify the mask path and control motion of instances, as well as how instances appear along the mask path when animated. In this overview individual controls are not explained in detail, instead focus is pointed at how these controls interact when combined. The first picture below shows the original mask path and a path segment defined by setting Start to 20 and End to 80. Using the original mask path, instances appear along the full length of the path. Using the path segment, instances appear in the defined segment only.

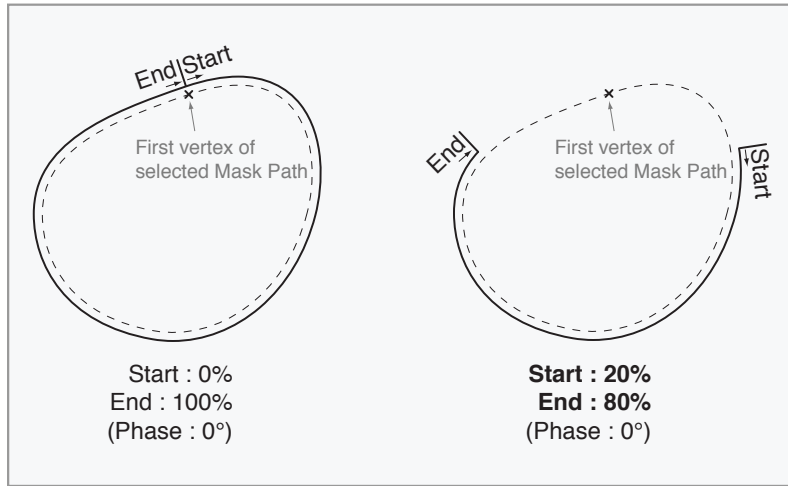

Example using Start % and End% to define a segment.

The Phase control offsets the segment defined by Start and End along the path. Cycle Path controls what happens if the segment is offset beyond either end of the path. With Cycle Path off, any instances passing beyond the path ends will be excluded. Turning on Cycle Path will cause the extending instances to wrap around to the opposite end of the path. The image below shows an example of a closed path with Cycle Path on and off.

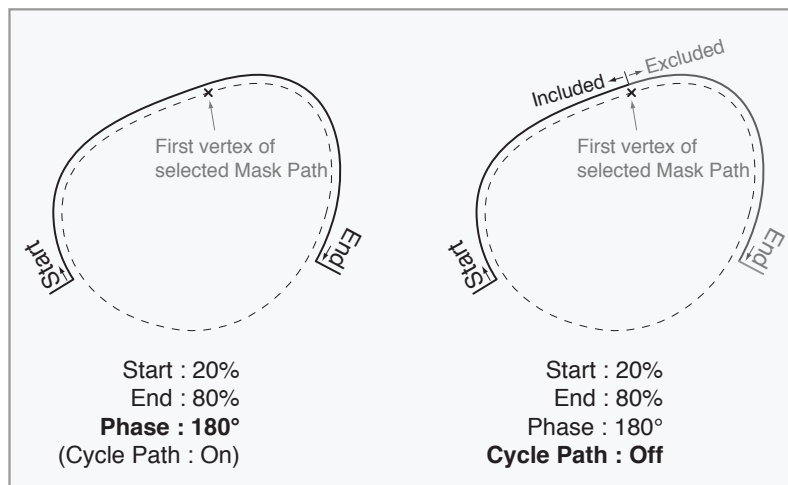

Example using Start % and End% to define a segment.

Path Segment (Group)

Start At % and End At %

Use these controls to define a segment of the path where a stroke is generated. Values are a percentage of the distance from the beginning or end of the total stroke. When animating, these controls are great to combine with the Phase control but they can also be used “stand alone” to animate strokes as the segment of the full path is altered when changing their values. Start At % and End At % values can overlap, i.e., end can be set before start and vice versa.

Phase

Use this control to offset the start and end points and thereby any segment defined, along the mask path.

Note. Animating this control does not affect any wiggle values but any curve defined in Taper Segment will be mapped accordingly.

Brush Color

Use this control to select a stroke color.

Supervised: This control is not used if a Color Gradient is chosen.

Brush Radius

Use this control to determine stroke width.

Brush Hardness

Use this control to determine the softness, or feathering, of stroke edges. 100% produce the hardest edge and 0% the softest edge.

Brush Opacity

Use this control to determine the stroke transparency.

:Wiggle Control Groups Overview:

As several properties in each group are the same, a more detailed explanation is provided in this overview and a shorter description in each individual group.

:Wiggle Type:

These controls specify the modifier to be used to wiggle a group property. Three kind of modifiers are available; basic noise, wave noise and wave functions. The below pictures shows an example of how each wiggle property is affected by the selected modifier. Properties from top to bottom, (P), (R), (O). Available options are:

Basic noise types:

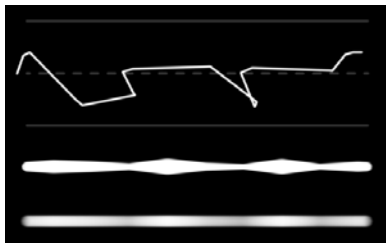

Linear Noise

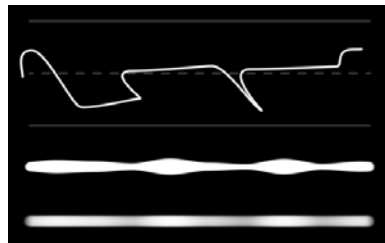

Softish Noise

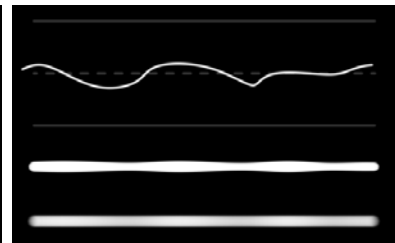

Smooth Noise

Wave noise types:

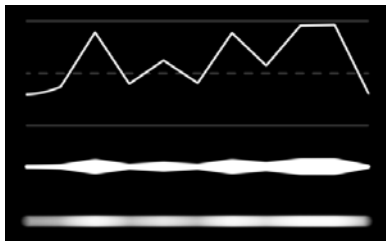

Linear Noise Wave

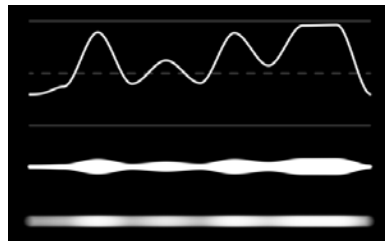

Softish Noise Wave

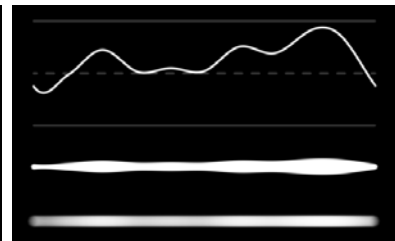

Smooth Noise Wave

Wave functions:

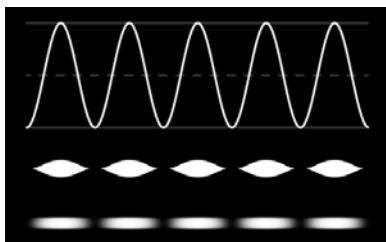

Sine Wave

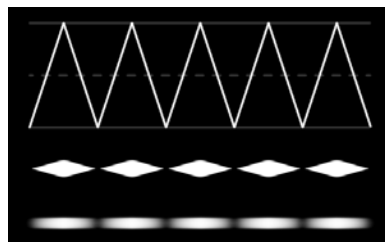

Triangular Wave

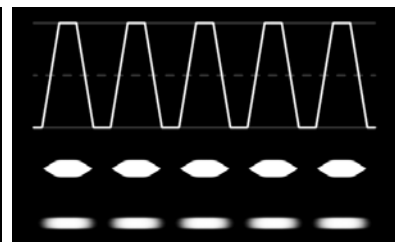

Cog Wave

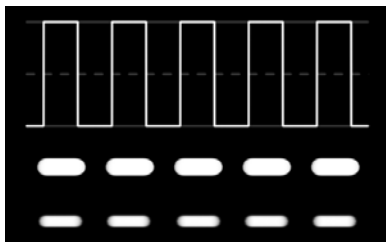

Square Wave

:Amount:

These controls determine the amount of wiggling applied to a strokes wiggling properties. The available properties are position (P), radius (R) and opacity (O). Each properties control name will be Amount followed by (P), (R), or (O). How amount affects each property is described below.

Amount (P) determines the displacement amount between a stroke and the original mask path. Higher values will produce greater wiggling, as the distance between the stroke and the original mask path will increase by greater amount.

Amount (R) determines the amount by which the radius will vary. This value is relative to the values set with Brush Radius. It will introduce both positive and negative values where at 100% the property will vary between twice the initial value and 0 (zero).

Example 1:

Brush Radius = 3.0

Amount (R) = 100

Radius will vary 3.0 pixels from its initial 3.0 pixel radius (3.0 ± 3.0 px).

Radius will vary: 0.0 pixel < (Stroke radius) < 6.0 pixel (3.0 ± 3.0 px).

Example 2:

Brush Radius = 3.0

Amount (R) = 50

Radius will vary 1.5 pixels from its initial 3.0 pixel radius (3.0 ± 1.5 px).

Radius will vary: 1.5 < (Stroke radius) < 4.5 (3.0 ± 1.5 px).

Amount (O) determines how many percent the opacity will wiggle from the initial value. This value is relative to the values set with Brush Opacity. It will introduce both positive and negative values where at 100% the opacity will vary between twice the initial value and 0 (zero).

Note : Opacity will never actually wiggle over 100%.

Example 1:

Brush Opacity = 100

Amount (O) = 100

Opacity will vary 100% from its initial 100% opacity value ($100\% \pm 100\%$).

Opacity will vary: 0 < (Stroke opacity) < 200 ($100\% \pm 100\%$).

Example 2:

Brush Opacity = 100

Amount (O) = 50

Opacity will vary 50% from its initial 100% opacity value ($100\% \pm 50\%$).

Opacity will vary: 50 < (Stroke opacity) < 150 ($100\% \pm 50\%$).

:Periods:

These controls determine how much detail wiggling will apply to a stroke. Higher values add more detail, which generates more frequent wiggles. Below are two examples of two different Periods settings for various wiggle types. Properties from top to bottom, (P), (P), (R), (O).

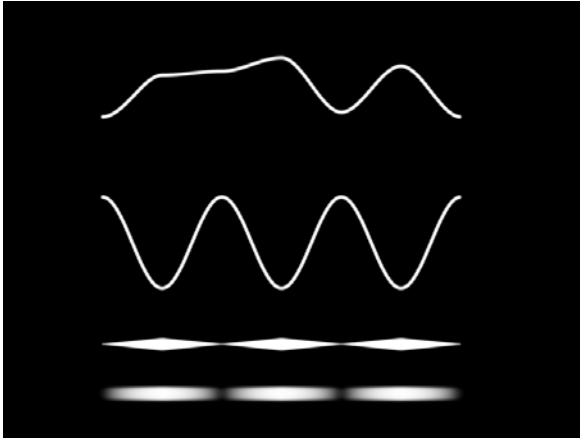

Periods = 3

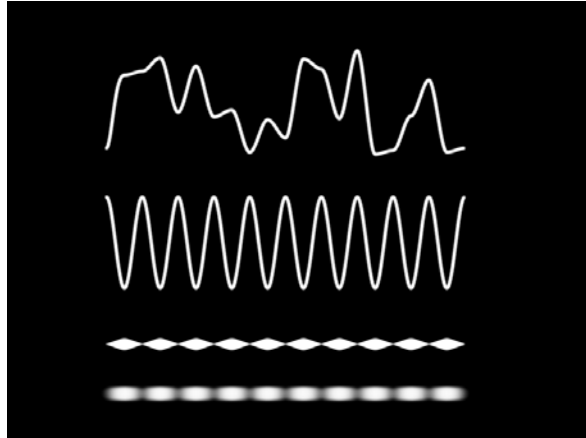

Periods = 10

Note. When using wave functions on a closed path it is necessary to use integer values for Periods in order to generate a continuous wave.

:Offset:

These controls move any wave type wiggling along the mask path. The value is percentage of the mask path length

:Evolve:

These controls change the appearance (or shape) of the noise. To use another word, the Evolve property can be seen as a “shape shifter” that can be interpolated in animation. Large changes in Evolve values between keyframes, causes noise to change more rapidly. Large changes in Evolve values over a short period of time may result in flashing, or even random animation, rather than smooth changes in the noise, e.g., animating Evolve by one unit per second is similar in speed to the pulse of a beating heart.

:Evolve Loop Period:

These controls create a seamless loop (or cycle) of evolving noise within a specified range. Evolve Loop Period can be used to seamlessly loop the Evolve property including the Evolve Delta properties in the Repeat control group, when enabled. Evolve Loop Period interpolates the noise, in a specific way, to return to its starting point in order to create a looping animation without the need to reverse-keyframe an Evolve property to return to its original state (or appearance), e.g., 0 -> 1 -> 0. Although setting keyframes which return to the same value will return noise to the same state, the animation may appear to simply being played back and forth rather than being a smooth transitioning loop, repeating itself as it interpolates between the keyframes. Instead, use Evolve Loop Period and the desired Evolve property

CPT Wiggle Stroke - Cycore Systems FX menu

to create a continuous smooth progressive loop (or loop segment). This control can save a great deal of rendering time. Use it to create a short seamless stroke wiggle (where the last frame matches up to the first) to be pre-rendered and looped as a new source layer in a composition, rather than setting Evolve to animate over a greater number of frames.

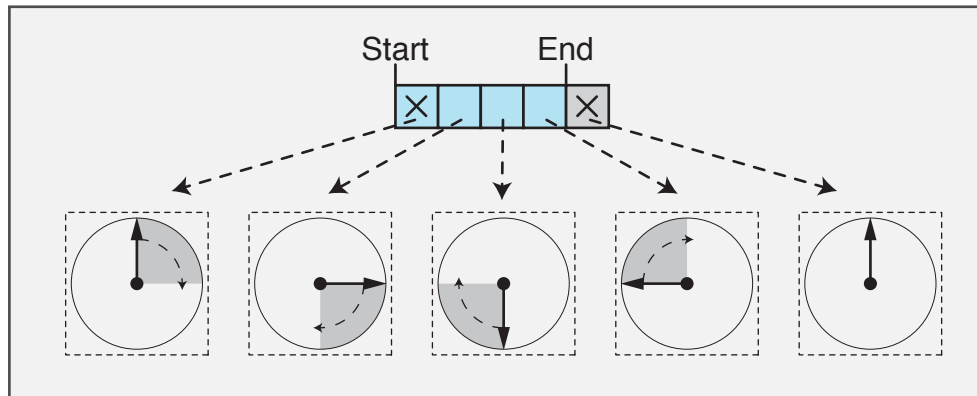

A seamless loop.

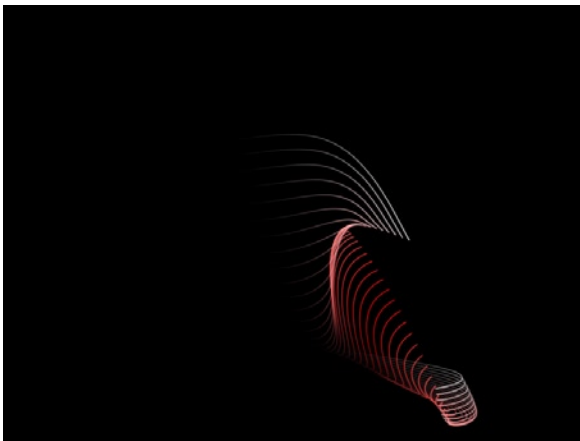

Evolve Loop Period = 0

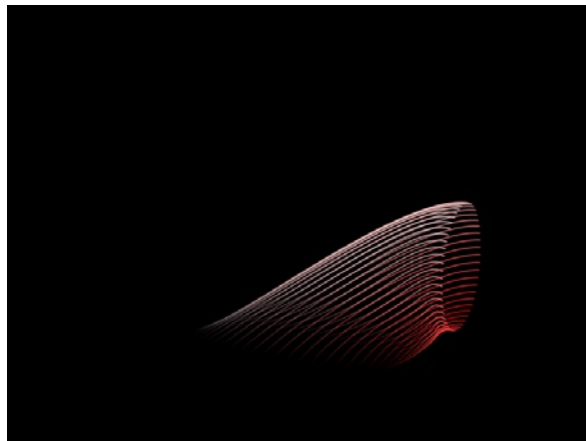

Evolve Loop Period = 1

More information on how to set up a property for seamless loop animation click [here](#).

:Noise Wave Loops:

These controls seamlessly loop (or cycle) a segment of a Noise Wave (Wiggle Type) a number of times along a mask path. E.g., setting this to four will repeat the first quarter segment of the noise wave four times along the mask path. Setting this to zero will create an infinitely long wave to travel (or offset) along the mask path, however for closed mask paths this setting will often result in a sharp transition where it is joined (start/end).

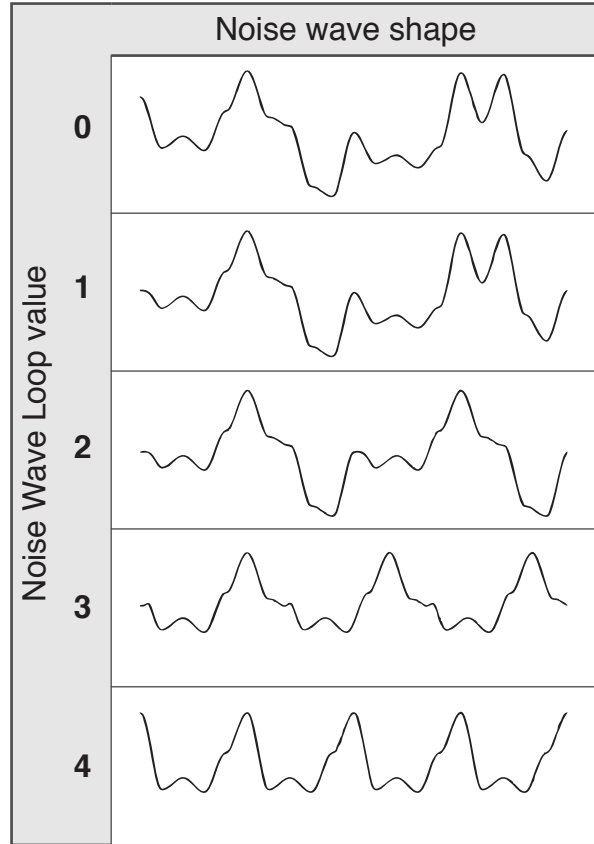

Different Noise Wave Loop settings.

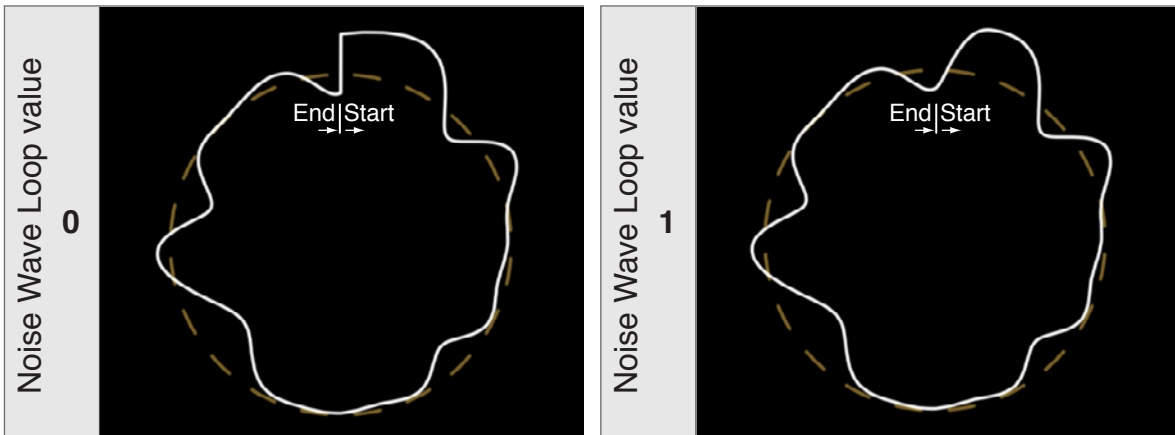

Note the sharp transition at start/end with Noise Wave Loop set to zero on a closed path.

Wiggle Position (Group)

Wiggle Type (P)

Use this pop-up menu to select the type of modifier to base position wiggling on. The available options are: Linear Noise, Softish Noise, Smooth Noise Linear Noise Wave, Softish Noise Wave, Smooth Noise Wave, Sine Wave, Triangular Wave, Cog Wave, Square Wave.

Amount (P)

Use this control to determine the amount of wiggling, or displacement, applied to strokes. Higher values will produce greater wiggling.

Periods (P)

Use this control to determine how much detail wiggling will apply to a stroke. Higher values add more detail, which generates more frequent wiggles.

Offset % (P)

This control will move any wave type wiggling along the mask path. The value is percentage of the mask path length.

Supervised: This control is disabled for basic noise types unless Twists Can Offset is enabled.

Evolve (P)

Use this control to change the appearance or shape of the noise. Large changes in Evolve values between keyframes, causes noise to change more rapidly.

Supervised: This control is disabled if a wave function is selected in Wiggle Type.

Evolve Loop Period (P)

Use this control to change the appearance or shape of the noise. Evolve Loop Period interpolates the noise to return to it's starting point in order to create a looping animation.

Supervised: This control is disabled if a wave function is selected in Wiggle Type.

Noise Wave Loops (P)

Use this control to seamlessly loop (or cycle) a segment of wave noise a number of times along a mask path.

Supervised: This control is enabled if a wave noise modifier is selected in Wiggle Type.

Wotate

Position Wiggling displace the stroke from the original mask path. Use this control to change/modify the direction in which wiggling will take place.

Twists

Use this control to introduce a continuous rotation of the displacement direction along the mask path.

Twist Can Offset

Check this control to link Twists to the Offset % control. When enabled Twists will move along the mask path when Offset changes.

Wiggle Radius (Group)

Wiggle Type (R)

Use this pop-up menu to select the type to base radius wiggling on. The available options are: Linear Noise, Softish Noise, Smooth Noise Linear Noise Wave, Softish Noise Wave, Smooth Noise Wave, Sine Wave, Triangular Wave, Cog Wave, Square Wave.

Amount (R)

Use this control to determine the percentage by which radius will be wiggled from the initial value set in the Brush Radius control. It will introduce both positive and negative values where at 100% the property will vary between twice the initial value and 0 (zero).

Periods (R)

Use this control to determine how much detail wiggling will apply to a stroke. Higher values add more detail, which generates more frequent wiggles.

Offset % (R)

This control will move any wave type wiggling along the mask path. The value is percentage of the mask path length.

Supervised: This control is disabled for basic noise types unless Twists Can Offset is enabled

Evolve (R)

Use this control to change the appearance or shape of the noise. Large changes in Evolve values between keyframes, causes noise to change more rapidly.

Supervised: This control is disabled if a wave function is selected in Wiggle Type

Evolve Loop Period (R)

Use this control to change the appearance or shape of the noise. Evolve Loop Period interpolates the noise to return to it's starting point in order to create a looping animation.

Supervised: This control is disabled if a wave function is selected in Wiggle Type

Noise Wave Loops (R)

Use this control to seamlessly loop (or cycle) a segment of a Noise Wave a number of times along a mask path.

Supervised: This control is enabled if a Noise Wave is selected in Wiggle Type

Wiggle Opacity (Group)

Wiggle Type (O)

Use this pop-up menu to select the type to base opacity wiggling on. The available options are: Linear Noise, Softish Noise, Smooth Noise Linear Noise Wave, Softish Noise Wave, Smooth Noise Wave, Sine Wave, Triangular Wave, Cog Wave, Square Wave

Amount (O)

Use this control to determine the percentage by which opacity will be wiggled from the initial value set in the Brush Opacity control. It will introduce both positive and negative values where at 100% the opacity will vary between twice the initial value and 0 (zero).

Note: Opacity will never actually wiggle over 100%.

Periods (O)

Use this control to determine how much detail wiggling will apply to a stroke. Higher values add more detail, which generates more frequent wiggles

Offset % (O)

This control will move any wave type wiggling along the mask path. The value is percentage of the mask path length.

Supervised: This control is disabled for basic noise types unless Twists Can Offset is enabled

Evolve (O)

Use this control to change the appearance or shape of the noise. Large changes in Evolve values between keyframes, causes noise to change more rapidly.

Supervised: This control is disabled if a wave function is selected in Wiggle Type

Evolve Loop Period (O)

Use this control to change the appearance or shape of the noise. Evolve Loop Period interpolates the noise to return to it's starting point in order to create a looping animation.

Supervised: This control is disabled if a wave function is selected in Wiggle Type

Noise Wave Loops (O)

Use this control to seamlessly loop (or cycle) a segment of a Noise Wave a number of times along a mask path.

Supervised: This control is enabled if a Noise Wave is selected in Wiggle Type

:Taper Control Groups Overview:

Tapering is often used to allow a property to become gradually smaller, less opaque etc, toward one or both ends. As Wiggle Stroke use a curve editor, these controls allows for gradually decreasing/increasing properties along the full length of the mask path. As the control group names implies there are two options, taper the full mask path or taper instances. Both taper options can be combined to get the desired result.

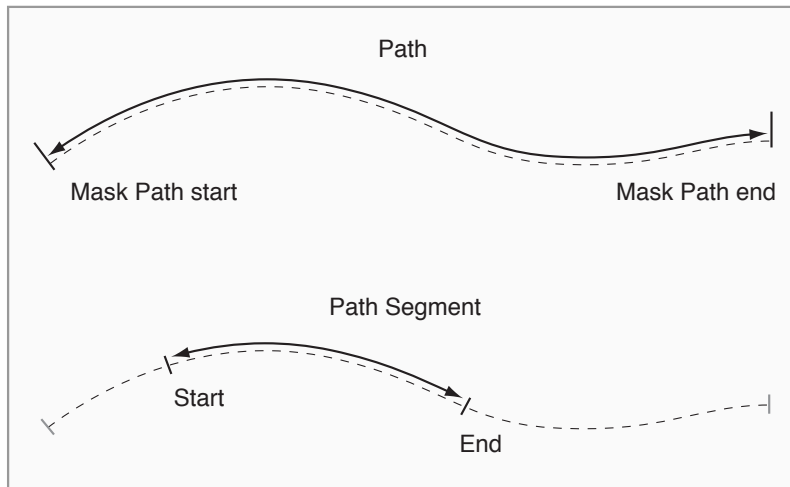

Example showing a full path and a path segment.

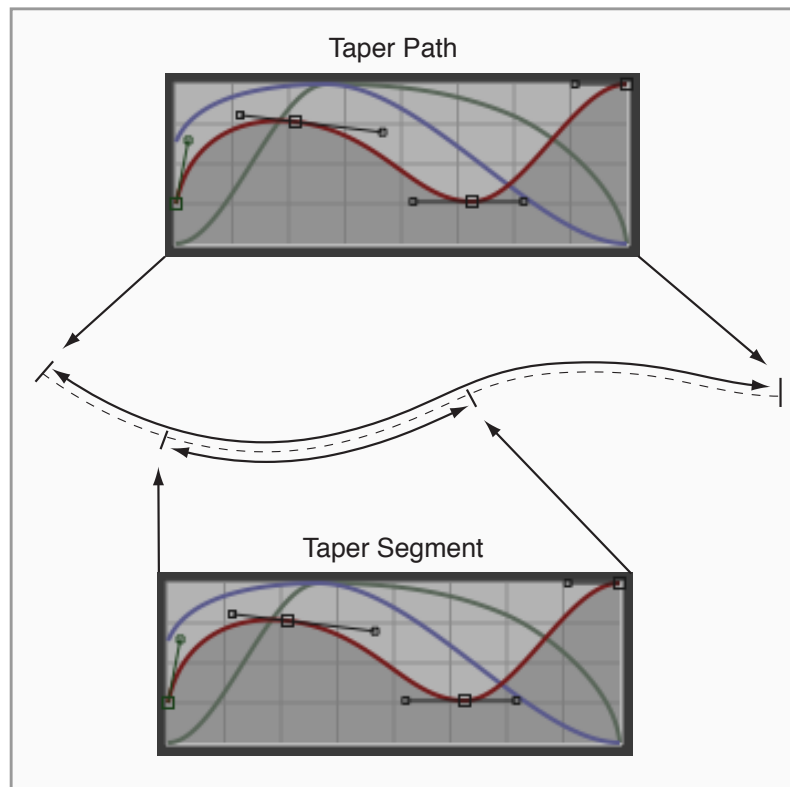

Example showing tapering a full path and/or a path segment.

CPT Wiggle Stroke - Cycore Systems FX menu

Curve editors have one main editor where all available taper properties can be accessed and edited, simply press the button for the desired property to activate for editing, while still being able to view curves for other properties as they are overlaid in the UI.

If higher precision is needed for fine tuning, each property has it's own curve editor representing the actual property in the main editor. These all have a larger curve editor UI and other inactive curves are not overlaid for a cleaner view. All changes done in the individual curve editors are reflected in the main editor UI. Individual taper controls can be animated.

Values are displayed in the editors interactively as you move a point. To check current values for any point, hover the mouse over the point and the current value is displayed in the After Effects Info window/panel.

Taper editors have an identifier (e.g., TS) to make it easy to quickly identify which taper property is which when working in the Timeline window/panel.

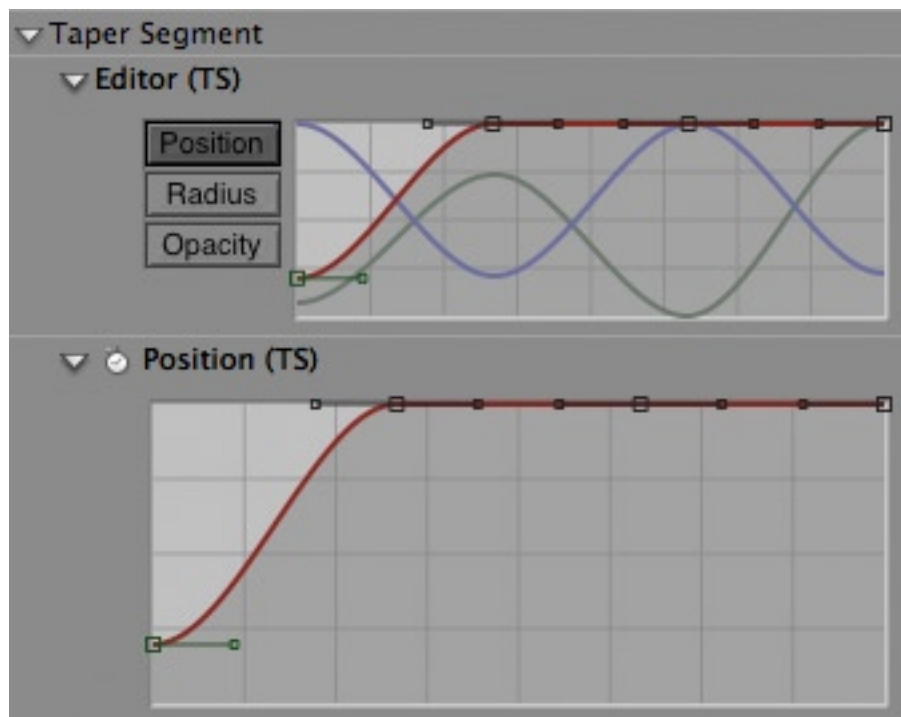

Main Editor and Solo Editor with inactive curves overlaid.

CPT Wiggle Stroke - Cycore Systems FX menu

Taper Path is applied over the whole path length. Taper Segment only affects the segment defined in Path Segment. Combining the two may occasionally cause one to cancel out the other. However, this interaction also provides great control over the applied tapering. The pictures show examples of taperings and how they interact.

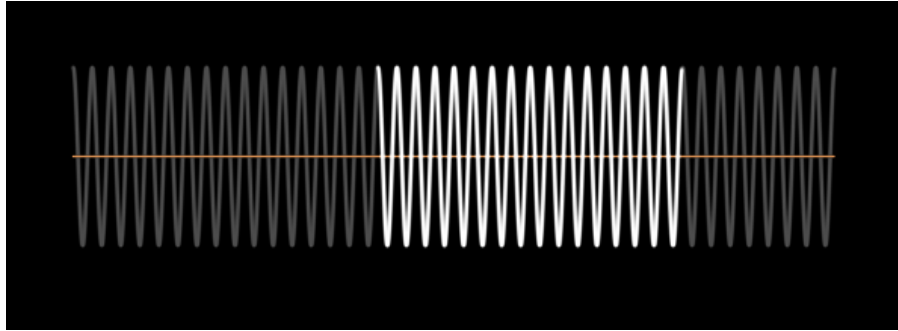

Segment defined. Start: 40 and End: 80

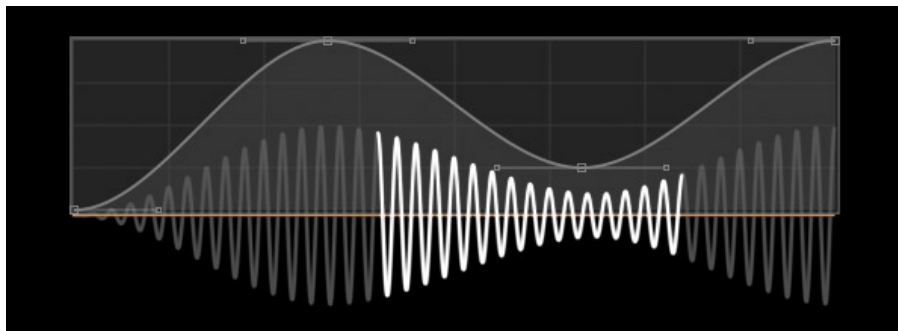

Taper Path applied.

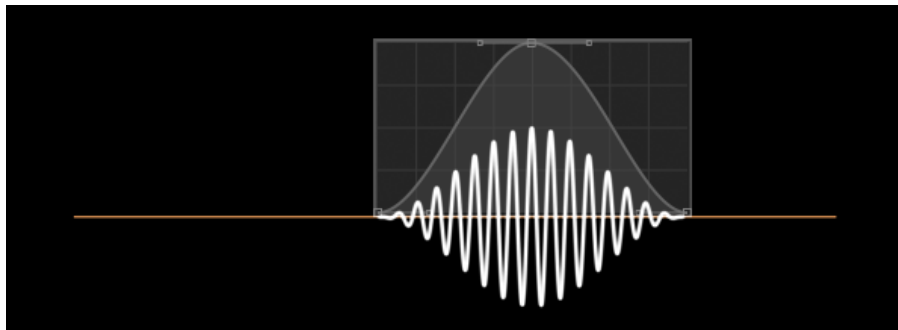

Taper Segment applied.

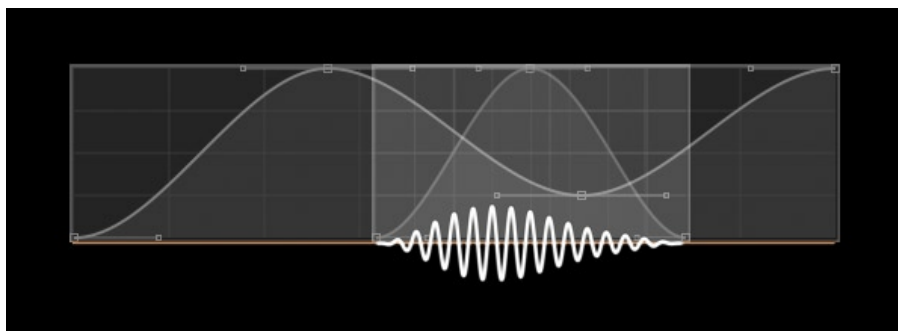

Taper Path and Taper Segment applied.

CPT Wiggle Stroke - Cycore Systems FX menu

At default settings all curve editors have four vertex points, but points can also be added or removed. To add/remove points use the following modifiers:

- Add a point: Option (Alt)-click on a curve adds a point at that position.
- Remove a point: Option (Alt)-click on the point.

Note. Option (Alt)-click close to a handle has no effect.

Curves and points can also be edited. To edit, use the following modifiers:

- Split direction handles: Cmd (Ctrl)-click and drag a direction handle.
- Move first and last points vertically with constraint: Shift-drag first or last point.

Taper Segment (Group)

Tapers the segment defined in the Path Segment control.

Editor (TS)

Main Editor. Click desired property to activate for editing. Curves for inactive properties are overlaid. Available properties are Position, Radius and Opacity.

Position (TS)

Solo editor for position, providing a larger curve editor UI. Changes are reflected in Main Editor.

Radius (TS)

Solo editor for radius, providing a larger curve editor UI. Changes are reflected in Main Editor.

Opacity (TS)

Solo editor for opacity, providing a larger curve editor UI. Changes are reflected in Main Editor.

Taper Path (Group)

Tapers the full mask path.

Editor (TP)

Main Editor. Click desired property to activate for editing. Curves for inactive properties are overlaid. Available properties are Position, Radius and Opacity.

Position (TP)

Solo editor for position, providing a larger curve editor UI. Changes are reflected in Main Editor.

Radius (TP)

Solo editor for radius, providing a larger curve editor UI. Changes are reflected in Main Editor.

Opacity (TP)

Solo editor for opacity, providing a larger curve editor UI. Changes are reflected in Main Editor.

:Repeat Control Group Overview:

The controls in the Repeat group adds an extra dimension to Wiggle Stroke. A stroke can be repeated and each repetition can vary from the previous. The variation can be set to be completely random (Randomize) or to affect specific wiggling properties in a controlled manner (Offset Delta & Evolve Delta). Delta values are values with which each repetition will add to specific wiggle property. Checking any Randomize control will disable the Offset Delta and Evolve Delta controls for that property.

The pictures below show some examples of a stroke repetition where delta values are used, in this case for the position Offset and Evolve properties.

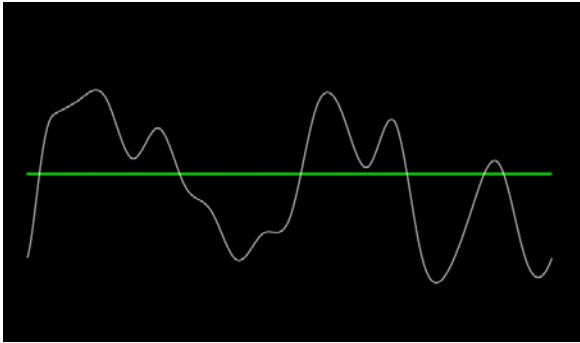

1 repetition. Delta values not used.

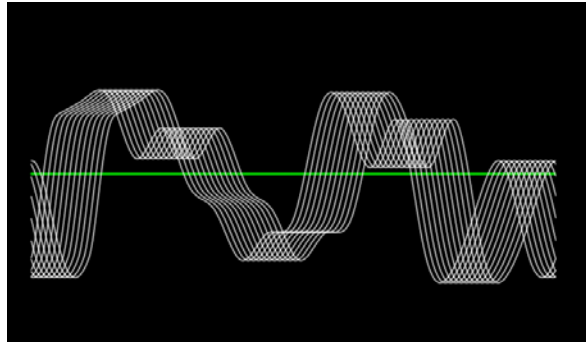

12 repetitions using Offset Delta.

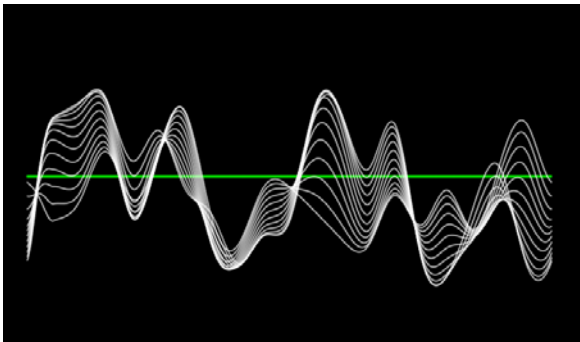

12 repetitions using Evolve Delta.

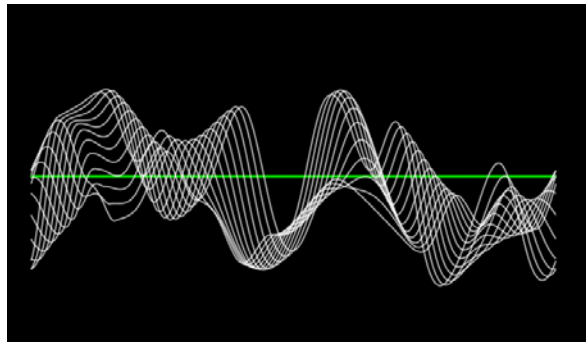

12 repetitions using Offset and Evolve Delta.

Repeat (Group)

Repetitions

Use this control to set the number of times a stroke is repeated. All other controls in this group will be disabled unless the stroke is repeated more than once.

Randomize Position Wiggle

Check this control to generate completely random position wiggle offset and evolve values for each repetition.

Position Offset Delta

Use this control to increase the Offset % (P) value by this amount for each repetition.

Supervised: Enabled when Wiggle Type (P) is set to any wave type, or if Twists Can Offset is enabled.

Position Evolve Delta

Use this control to increase the Evolve (P) value by this amount for each repetition.

Supervised: Enabled when Wiggle Type (P) is set to any noise type.

Randomize Radius Wiggle

Check this control to generate completely random radius wiggle offset and evolve values for each repetition.

Radius Offset Delta

Use this control to increase the Offset % (R) value by this amount for each repetition.

Supervised: Enabled when Wiggle Type (R) is set to any wave type.

Radius Evolve Delta

Use this control to increase the Evolve (R) value by this amount for each repetition.

Supervised: Enabled when Wiggle Type (R) is set to any noise type.

Randomize Opacity Wiggle

Check this control to generate completely random opacity wiggle offset and evolve values for each repetition.

Opacity Offset Delta

Use this control to increase the Offset % (O) value by this amount for each repetition.

Supervised: Enabled when Wiggle Type (O) is set to any wave type.

Opacity Evolve Delta

Use this control to increase the Evolve (O) value by this amount for each repetition.

Supervised: Enabled when Wiggle Type (O) is set to any noise type.

:Extras Control Group Overview:

For some of the controls in Extras a more detailed explanation is provided in this overview and a shorter description in each individual group.

:Color Gradient:

Gradients can be applied to segments and/or repetitions. There are two pop-up controls, Segment Gradient and Repetition Gradient, that both have three options to choose from, None, Linear or Triangular.

None: Disables gradients for segments and/or repetitions, i.e., Brush Color is used

Linear: Applies a linear gradient from the start to end points of a segment or repetitions. Colors are interpolated from the first selected color to the second color. For closed paths this may result in a sharp transition where End joins Start

Triangular: Applies a triangular gradient from start to end points of a segment or repetitions. Colors are interpolated from the first selected color, to the second and back to the first color, creating a seamless gradient.

If gradients are applied to only a segment or repetitions the following color controls are enabled to select the desired color:

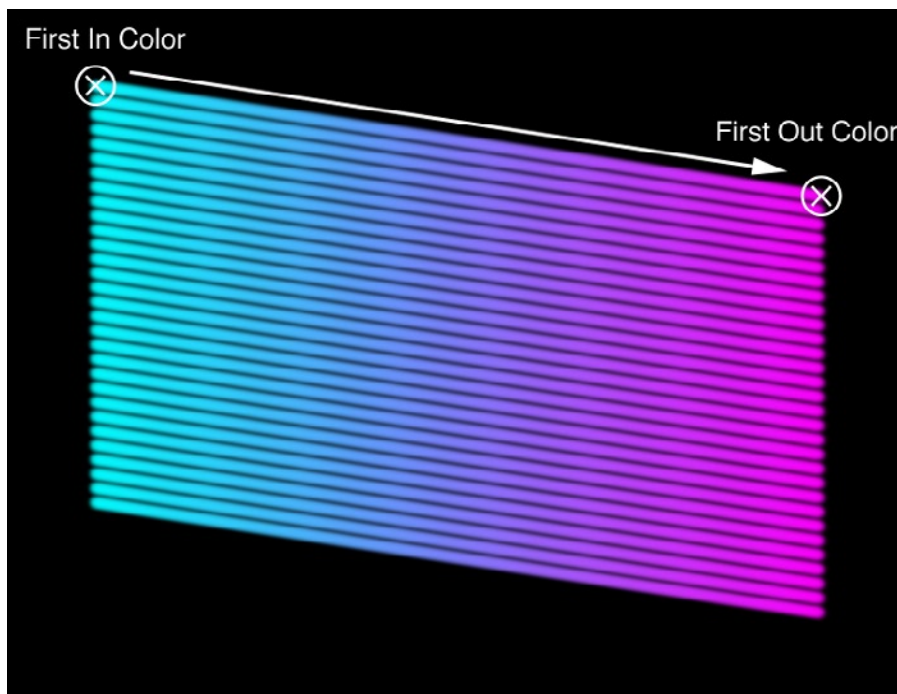

Segment Gradient only. Select colors using First In Color and First Out Color.

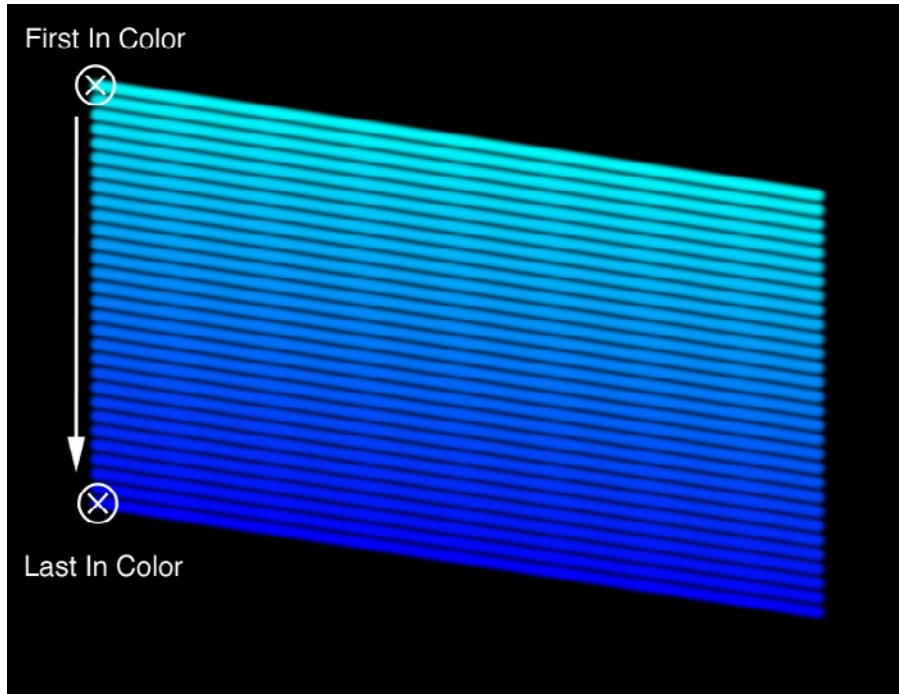

Repetition Gradient only. Select colors using First In Color and Last In Color.

If gradients are applied to both a segment and repetitions the Last Out Color control is enabled. The fourth color is needed to interpolate four gradients in four directions that are blended together. The following controls are enabled to select the desired color:

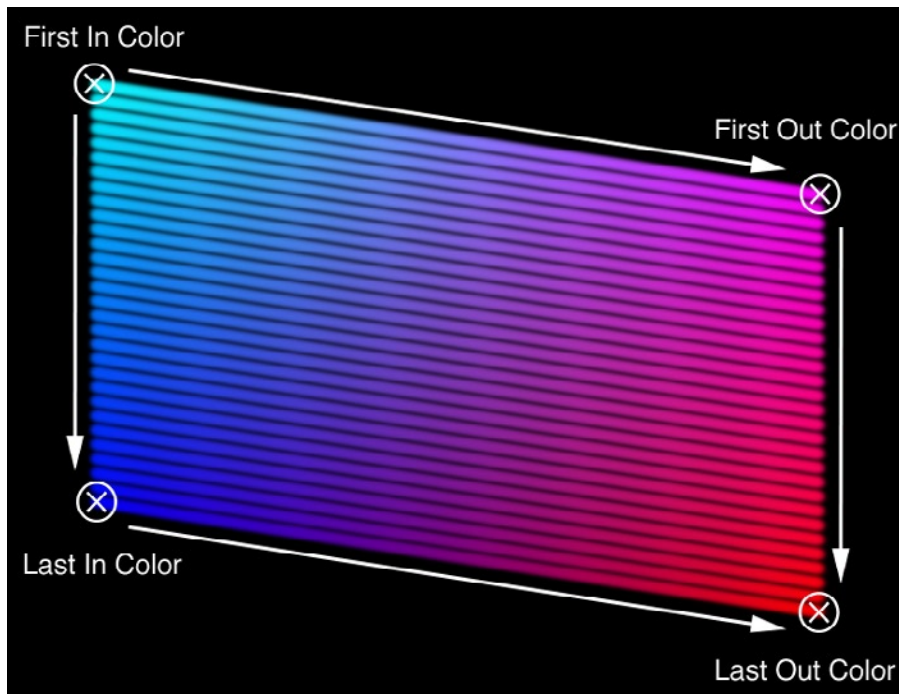

Segment Gradient and Repetition Gradient. All In and Out Color controls are enabled.

Extras (Group)

Brush Transfer Mode

Use this pop-up menu to select which composite method to use when generating a stroke. Each offers a different result. Choose one of the following options, Composite, Screen, Add.

Color Gradient (Sub-group)

Segment Gradient

Use this pop-up menu to enable segment gradient.

Repetition Gradient

Use this pop-up menu to enable segment gradient.

Supervised: Enabled if a stroke is repeated more than once.

First In Color

Use this control to select the first in color for the gradient.

Supervised: Enabled when Segment or Repetition gradient is used.

First Out Color

Use this control to select the first out color for the gradient.

Supervised: Enabled when Segment Gradient is used.

Last In Color

Use this control to select the last in color for the gradient.

Supervised: Enabled when Repetition Gradient is used.

Last Out Color

Use this control to select the last out color for the gradient.

Supervised: Enabled when Segment and Repetition Gradient is used.

Random Seed

Use this control to set a unique random seed value for wiggling. This makes it easy to use multiple layers, using the same Wiggle Stroke animation, and only change the Random Seed value to give each layer a unique look.

Synchronize Noise Seeds

Check this option to add some sort of order to random wiggling. All noise and random values use a common base from which they are generated. This will affect all noise Wiggle Type as well as Randomize options (In the Repeat Group).

Example 1:

Position and Radius wiggle both set to Softish Noise Wave and same Period.

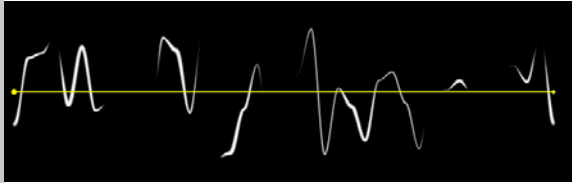

Synchronize Noise Seeds - Off.

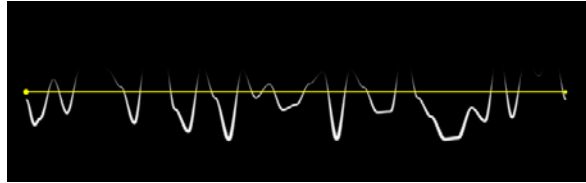

Synchronize Noise Seeds - On.

Example 2:

Repeat with Position and Radius set to Randomize Wiggle. Same wiggle Period.

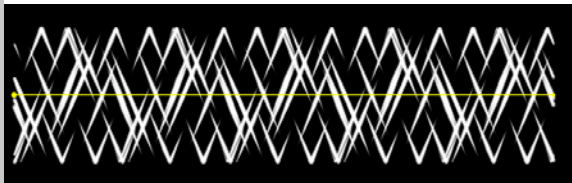

Synchronize Noise Seeds - Off.

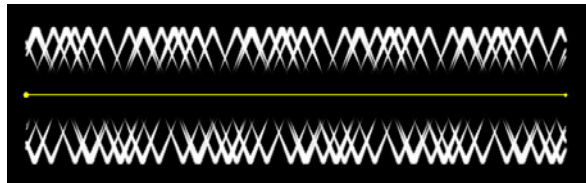

Synchronize Noise Seeds - On.

CFX Path Tools - Thanks To

Special thanks goes to:

Our beta testers

The CoSA After Effects Team

Jonatan Andersson and Johan Lindh

Gorgen Abrami

And last but not least, our families!